

Differential pressure switch for air, flue and exhaust gases

LGW...A2, LGW...A2P
LGW...A2-7

DUNGS[®]
Combustion Controls

5.13

neuvità
nouveau new

LGW...A2, LGW...A2-7

- RoHS II 2011/65/EU



Technical description

The differential pressure switches LGW...A2... are adjustable differential pressure switches as per EN 1854 for automatic burner controls.

Suitable for switching a circuit on, off or over on changes in actual pressure value relative to the set reference value.

The reference value (switching point) is adjusted on a setting wheel provided with a scale. On LGW...A2P: test button integrated in lower part as standard.

Application

Differential pressure monitoring in firing, ventilation and air-conditioning systems. Suitable for air, flue and exhaust gases and other non-aggressive gases as differential pressure switches; not suitable for industrial combustion gases.

Approvals

EC type testing certificate as per:

- EC-Gas Appliances Regulation
- EC-Pressure Equipment Directive

Pressure switch class "S" as per EN 1854.

Special designs for the North American market with U_L, FM and CSA registrations.

Approvals in other important gas-consuming countries.

Functional description

Differential pressure switch in pressure and vacuum range. The differential pressure acts via the diaphragm against the force of the setting spring on the microswitch. The pressure switch operates without auxiliary power.

Differential pressure switch

The control unit responds to differential pressure. If the set reference value (mbar) is exceeded or undershot, the circuit is switched on, off or over.

LGW...A2P test button

The LGW...A2P differential pressure switch is equipped with a test button. The test button permits a service-friendly check of the safety function. If the test key is pressed while the pressure exists, the connection to the pressure connection **G 1/4** is interrupted and the pressure under the diaphragm is released. The microswitch of the pressure switch changes the contact position from NO to NC. If the test button is released, the pressure below the diaphragm is built up again and the microswitch changes to its original position.

Switching function

As pressure rises:

1 NC opens, 2 NO closes

As pressure falls:

1 NC closes, 2 NO opens

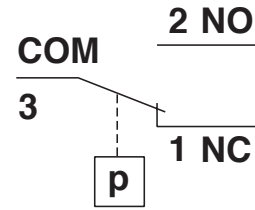

Definition of switching difference Δp

The switching difference Δp is the pressure difference between the upper and lower switching pressures.

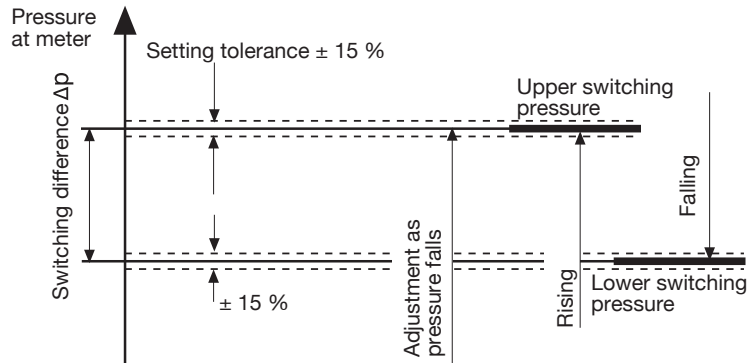

Dimensions [mm] LGW...A2, LGW...A2-7

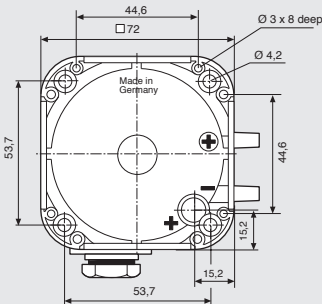
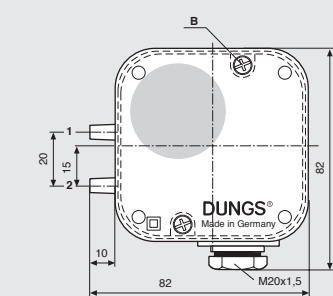
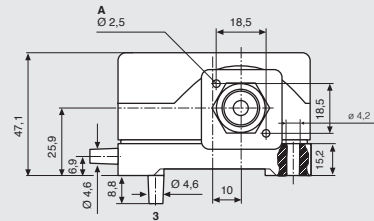

LGW...A2P

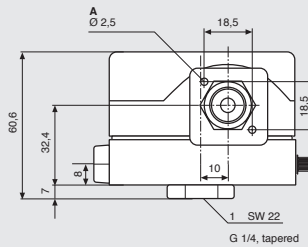

Pressure connection (+) $\varnothing 4.6$ can only be used as test nipple. Pressure connection only possible using G 1/4.

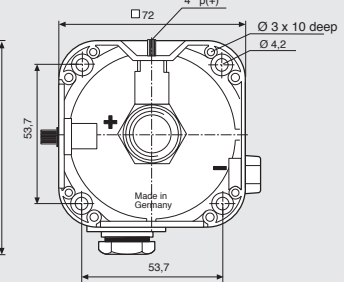
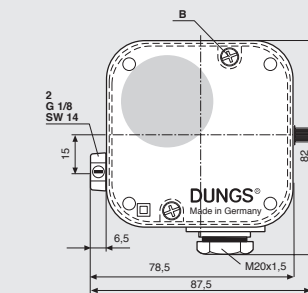

- A 2.5 dia for equipment plug as per DIN EN 175 301-803
- B Oblong slot: 0.8 and cross-head as per DIN 7962-Z 2
- 1 Pressure connection (+)
- 2 Pressure connection (-)
- 3 Only LGW... A2 optional pressure connection (+)
- 4 Test button p (+)

Specifications

Max. operating pressure	LGW 3 A2 - LGW 150 A2	500 mbar (50 kPa)		
	LGW 3 A2P - LGW 150 A2P	500 mbar (50 kPa)		
	LGW 1,5A2-7 - LGW 10A2-7	100 mbar (10 kPa)		
Ranges	LGW...A2, ...A2P	LGW...A2-7		
	0.4 - 3 mbar	20 - 150 Pa		
	1 - 10 mbar	20 - 300 Pa		
	2.5 - 50 mbar	30 - 600 Pa		
	30 - 150 mbar	0.1 - 1 kPa		
Pressure connection	LGW...A2, LGW...A2-7: hose gland \varnothing 4.6 mm LGW...A2P: G 1/4 tapered female thread for higher pressure on centre of housing underside, including test button and on the side 4.6 dia. test point; G 1/8 female thread for lower pressure.			
Temperature range	Ambient temperature	LGW...A2, LGW...A2P	LGW...A2-7	
	Medium temperature	-15 °C bis +70 °C	-15 °C bis +85 °C	
	Storage temperature	-15 °C bis +70 °C	-15 °C bis +85 °C	
		-30 °C bis +85 °C	-30 °C bis +85 °C	
Materials	Housing	Polycarbonat		
	Switch	Polycarbonat		
	Diaphragms	NBR		
	Switching contact	LGW...A2, A2P	Ag, optional Ag gold plated (Au)	
		LGW...A2-7	Ag, gold plated (Au)	
		Au contacts are suitable for DDC applications: DC 24 V; 0.01 A		
Switching voltage	Ag contact	AC eff.	min. 24 V	max. 250 V
		DC	min. 24 V	max. 48 V
	Au contact	DC	min. 5 V	max. 24 V
Nominal current	Ag contact LGW...A2, A2P	AC eff.	10 A	
	Ag contact LGW...A2-7	AC eff.	6 A	
	Au contact	DC	20 mA	
Switching current	Ag contact LGW...A2, A2P	AC eff. at $\cos \varphi$ 1	min. 20 mA	max. 6 A
	Ag contact LGW...A2, A2P	AC eff. at $\cos \varphi$ 0,6	min. 20 mA	max. 3 A
	Ag contact LGW...A2-7	AC eff. at $\cos \varphi$ 1	min. 20 mA	max. 4 A
	Ag contact LGW...A2-7	AC eff. at $\cos \varphi$ 0,6	min. 20 mA	max. 2 A
		DC	min. 20 mA	max. 1 A
	Au contact	DC	min. 5 mA	max. 20 mA
Electrical connection	Standard	At screw terminals via M20x1.5 cable entry		
	Special design	Plug connection for line sockets as per DIN EN 175 301-803, 3-pin		
Degree of protection	IP 54 IEC 529 (EN 60529), protection insulated, optional IP 65			
Setting tolerance	\pm 15 % switching point deviation, relative to nominal value, with vertical mounting position. Rising (\uparrow) or falling (\downarrow) setting available on site.			
Deviation	Permissible deviation of the set value $\leq \pm$ 15 % in the service life test according to EN 1854			

Installation position

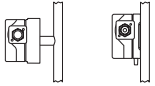
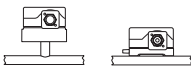
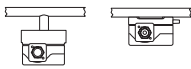
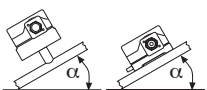
	Standard installation position \pm 0 mbar or \pm 0 Pa
	Installed horizontally ca. +0,5 mbar or +50 Pa
	Horizontally overhead ca. -0,5 mbar or -50 Pa
	Intermediate installation position max \pm 0,5 mbar or \pm 50 Pa

Differential pressure switch for air,
flue and exhaust gases

LGW...A2, LGW...A2P
LGW...A2-7



Technical data 1 mbar = 100 Pa = 0,1 kPa ≈ 10 mm WS 1 Pa = 0,01 mbar ≈ 0,1 mm WS

Type	Version [AG-M-V9]	Order No. 1 piece	Order No. 60 pieces	Setting range		min. / max.		Switching difference [mbar]
				[mbar]				
LGW...A2 Differential pressure switch	LGW 3 A2	272337	107409	0,4 - 3		± 0,1	± 15 %	
	LGW 10 A2	272336	107417	1 - 10		± 0,2	± 15 %	
	LGW 50 A2	272341	107425	2,5 - 50		± 0,75	± 15 %	
	LGW 150 A2	272356	107433	30 - 150		-	± 15 %	
LGW...A2P Differential pressure switch	LGW 3 A2P	272352	120204	0,4 - 3		0,1	± 15 %	
	LGW 10 A2P	272345	120212	1 - 10		± 0,2	± 15 %	
	LGW 50 A2P	272346	221207	2,5 - 50		± 0,75	± 15 %	
	LGW 150 A2P	272354	120238	30 - 150		-	± 15 %	
Typ	Version [AU-M-V9]	Order No. 1 piece	Order No. 60 pieces	Setting range		min. / max.		Switching difference [Pa]
				[Pa]				
LGW...A2-7 Differential pressure switch	LGW 1,5 A2-7	257434	-	20 - 150		± 8	± 15 %	
	LGW 3 A2-7	257435	-	20 - 300		± 8	± 15 %	
	LGW 6 A2-7	257436	-	30 - 600		± 10	± 15 %	
	LGW 10 A2-7	257437	-	0,1 - 1 kPa		-	± 15 %	

**Accessories for
LGW...A2, LGW...A2P**

Kit: G3 equipment plug, 3-pin without ground	231770
Line socket, 3-pin + E, grey GDMW	210318
KlimaSet accessories KS A2-7	258247
G 1/8 screw-in gland	230278
G 1/4 screw-in gland	230279
Additional test button, complete PT 4	224940
Attachment plate	230301
Mounting kit glow lamp 230 V yellow	231773
Mounting kit glow lamp 120 V yellow	231772
Mounting kit display-LED 24 V yellow	231774
Mounting kit glow lamp 230 V green	248239
Mounting kit display-LED 24 V green	248240
Replacement-set hood IP 65	257841
Adapter ø 4/6 (2 x)	266037
Cylinder head screw ø 3 x 14 (2 x)	266045

We reserve the right to make any changes in the interest of technical progress.

Head Offices and Factory
Karl Dungs GmbH & Co. KG
Karl-Dungs-Platz 1
D-73660 Urbach, Germany
Telephone +49 7181-804-0
Telefax +49 7181-804-166

Postal address
Karl Dungs GmbH & Co. KG
Postfach 12 29
D-73602 Schorndorf, Germany
e-mail info@dungs.com
Internet www.dungs.com