

Standard capsule pressure gauges



EN 837-3



- With zero correction
- Optional overpressure and/or underpressure safety 10 x FSD
- Extremely low measuring range from 0/6 mbar
- GOSSTANDART-certified

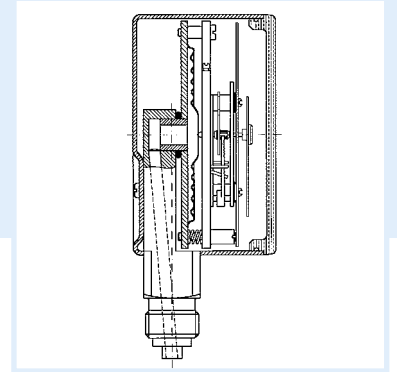

Application For gaseous, dry media which do not attack copper alloys.

Technical specifications

Type

D 4

Nominal size

63 – 100 – 160

Accuracy class (EN 837-3/6)

1.6

Ranges (EN 837-3/5)

NG 63-100 0/25 to 0/1000 mbar
 NG 160 0/6 to 0/1000 mbar
 and all corresponding vacuum and compound ranges with overpressure protection

Application area

Static load: full scale value
 Dynamic load: 0.9 x full scale value
 Overload safety: 1.3 x full scale value

Operating temperature range

Medium: $T_{max} = +60\text{ °C}$
 Ambient: $T_{min} = -20\text{ °C}$
 $T_{max} = +60\text{ °C}$

Temperature performance

Indication error when the temperature of the measuring system deviates from the normal temperature of +20 °C:
 rising temperature approx. $\pm 0.6\text{ %}/10\text{ K}$
 falling temperature approx. $\pm 0.6\text{ %}/10\text{ K}$
 of full scale value

Degree of protection

NG 63-160: IP 33 (EN 60529)
 NG 100: IP 54 (EN 60529)

Standard version

Connection

Brass, bottom or centre back
 NG 63 G $\frac{1}{4}$ B – spanner size SW 14
 NG 100 – 160 G $\frac{1}{2}$ B – spanner size SW 22
 (EN 837-3/7.3)

Measuring element

Capsule element, CuBe alloy

Movement

Brass

Zero correction

From the front

Seal

NBR (Perbunan)

Dial

Aluminium, white
 Dial marking black

Pointer

Aluminium, black

Housing

Stainless steel 304

Bayonet type bezel

Stainless steel 304

Window

Instrument glass
 Panel mounted devices (types D 431/451):
 Plastic (PMMA)

Options

- Overpressure and underpressure safety 10 x FSD
- Back flange
- Panel mounting bezel, with window, plastic
- 3-hole fixing, panel mounting bezel with window, plastic
- Damping screw
- Reference pointer
- Special scales
- Other process connections



See page 14 for prices.

Standard capsule pressure gauges

Type D 4 – NG 63/100/160

1 Housing types and dimensions

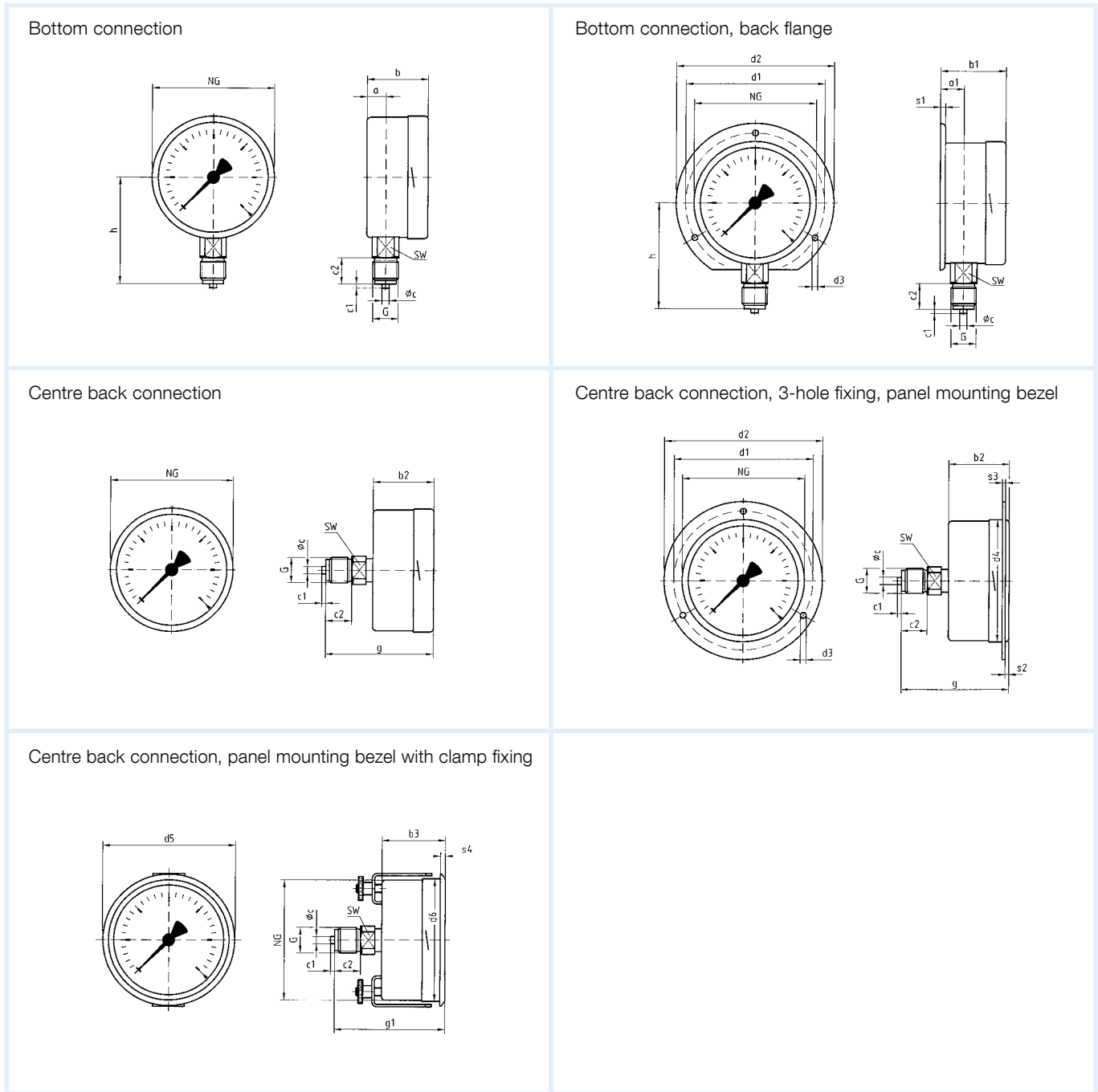

Dimensions (mm)

Nominal size (NG)	a	a1	b	b1	b2	b3	Øc	c1	c2	d1*	d2	d3*	d4	d5	d6	G	g	g1	h	s1	s2
63	10.8	13.4	40	42.1	37	37	5	2	13	75	85	3.5	64	68	64	G ¹ / ₄ B	60	60	53	5.2	3
100	15.6	19.1	49	52.5	49	49	6	3	20	116	132	4.8	104	107	101	G ¹ / ₂ B	81	81	86	5.5	4
160	17.5	20.5	50	53	50	52	6	3	20	178	196	5.8	164	167	161	G ¹ / ₂ B	82	84	116	6	4
Nominal size (NG)	s3	s4	SW																		
63	2	3	14																		
100	2	4	22																		
160	2	4.5	22																		







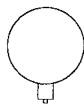

* Dimensions for NG 100 according to DIN 16014.

Standard capsule pressure gauges

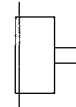
EN 837-3

DG: M, PG: 2

1

Type	KP63, D401	KP63, D411	KP63, D431	KP63, D451	KP100, D401	KP100, D411	KP100, D431	KP100, D451
Version								
Housing Ø	63	63	63	63	100	100	100	100
Housing	Stainless steel 304 with bayonet bezel, window, see data sheet							
Measuring element	Capsule element, CuBe alloy							
Accuracy class	1.6	1.6	1.6	1.6	1.6	1.6	1.6	1.6
Connection	G¼B	G¼B	G¼B	G¼B	G½B	G½B	G½B	G½B
			3-hole fixing, panel mounting bezel, 304, polished	Panel mounting bezel, 304, polished, with clamp fixing			3-hole fixing, panel mounting bezel, 304, polished	Panel mounting bezel, 304, polished, with clamp fixing
Range (mbar)	Part no.	Part no.	Part no.	Part no.	Part no.	Part no.	Part no.	Part no.
Price €								
-25/0	35004401	35004411	35004431	35004451	35104401	35104411	35104431	35104451
-40/0	35005401	35005411	35005431	35005451	35105401	35105411	35105431	35105451
-60/0	35006401	35006411	35006431	35006451	35106401	35106411	35106431	35106451
-100/0	35007401	35007411	35007431	35007451	35107401	35107411	35107431	35107451
-160/0	35008401	35008411	35008431	35008451	35108401	35108411	35108431	35108451
-250/0	35009401	35009411	35009431	35009451	35109401	35109411	35109431	35109451
-400/0	35010401	35010411	35010431	35010451	35110401	35110411	35110431	35110451
-600/0	35011401	35011411	35011431	35011451	35111401	35111411	35111431	35111451
-1000/0	35012401	35012411	35012431	35012451	35112401	35112411	35112431	35112451
Price €								
0/25	35016401	35016411	35016431	35016451	35116401	35116411	35116431	35116451
0/40	35017401	35017411	35017431	35017451	35117401	35117411	35117431	35117451
0/60	35018401	35018411	35018431	35018451	35118401	35118411	35118431	35118451
0/100	35019401	35019411	35019431	35019451	35119401	35119411	35119431	35119451
0/160	35020401	35020411	35020431	35020451	35120401	35120411	35120431	35120451
0/250	35021401	35021411	35021431	35021451	35121401	35121411	35121431	35121451
0/400	35022401	35022411	35022431	35022451	35122401	35122411	35122431	35122451
0/600	35023401	35023411	35023431	35023451	35123401	35123411	35123431	35123451
0/1000	35024401	35024411	35024431	35024451	35124401	35124411	35124431	35124451

Minimum order quantity for non-stock items = 10 pieces.

Blue part no. = in-stock items







See page 20 for extra charges.

Capsule pressure gauges

EN 837-3

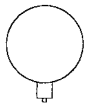
DG: M, PG: 2

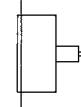
1

Type	KP160, D401	KP160, D411	KP160, D431	KP160, D451
Version				
Housing Ø	160	160	160	160
Housing	Stainless steel 304 with bayonet bezel			
Measuring element	Capsule element, CuBe alloy			
Accuracy class	1.6	1.6	1.6	1.6
Connection	G½B	G½B	G½B	G½B
			3-hole fixing, panel mounting bezel, 304, polished	Panel mounting bezel, 304, polished, with clamp fixing
Range (mbar)	Part no.	Part no.	Part no.	Part no.
Price €				
-6/0	35151401	35151411	35151431	35151451
-10/0	35152401	35152411	35152431	35152451
-16/0	35153401	35153411	35153431	35153451
Price €				
-25/0	35154401	35154411	35154431	35154451
-40/0	35155401	35155411	35155431	35155451
-60/0	35156401	35156411	35156431	35156451
-100/0	35157401	35157411	35157431	35157451
-160/0	35158401	35158411	35158431	35158451
-250/0	35159401	35159411	35159431	35159451
-400/0	35160401	35160411	35160431	35160451
-600/0	35161401	35161411	35161431	35161451
-1000/0	35162401	35162411	35162431	35162451
Price €				
0/6	35163401	35163411	35163431	35163451
0/10	35164401	35164411	35164431	35164451
0/16	35165401	35165411	35165431	35165451
Price €				
0/25	35166401	35166411	35166431	35166451
0/40	35167401	35167411	35167431	35167451
0/60	35168401	35168411	35168431	35168451
0/100	35169401	35169411	35169431	35169451
0/160	35170401	35170411	35170431	35170451
0/250	35171401	35171411	35171431	35171451
0/400	35172401	35172411	35172431	35172451
0/600	35173401	35173411	35173431	35173451
0/1000	35174401	35174411	35174431	35174451

Minimum order quantity for non-stock items = 10 pieces.

Blue part no. = in-stock items



See page 20 for extra charges.